

# User Manual

**W. VERLY**

AutoPette™ Electronic Pipettes



CE FC

# CONTENTS

1. Product Overview.....	- 1 -
2. Parts Description.....	- 3 -
3. Display.....	- 5 -
4. Operation.....	- 6 -
5. AutoPette setup.....	- 13 -
6. Storage.....	- 17 -
7. Care and Maintenance.....	- 18 -
8. Calibration and Performance Tests.....	- 23 -
9. Troubleshooting Guide.....	- 24 -
10. Warranty.....	- 26 -
11. Accessory.....	- 27 -

# 1. Product Overview

A versatile, motor-driven pipetting instrument, AutoPette delivers accurate and precise performance in liquid handling. Its design and operation is based on the principle of air displacement and use disposable pipette tips.

AutoPette has been tested according to ISO8655 quality management standards. In compliance with the quality control requirements of ISO8655-6 / DIN 12650, each and every AutoPette, fitted with original tip of the manufacturer, has been tested for gravity with distilled water (DIN / ISO3696, grade 3) at 22°C.

## 1.1 Specifications

dPette+ covers a wide range of volume: 0.5 - 10 $\mu$ L; 5 - 50  $\mu$ L; 30 - 300 $\mu$ L; 100 - 1000 $\mu$ L

Channels	Volume Range	Increment	Tips
1	0.5-10 $\mu$ L	0.01 $\mu$ L	10 $\mu$ L
1	5-50 $\mu$ L	0.1 $\mu$ L	200;300;350 $\mu$ L
1	30-300 $\mu$ L	1 $\mu$ L	300;350 $\mu$ L
1	100-1000 $\mu$ L	5 $\mu$ L	1000 $\mu$ L

## 1.2 Pipette Tip

AutoPette is compatible with most universal tip brands covering full volume range.

**Note!** Never use AutoPette without a tip attached.

### Contents of Package Include:

- AutoPette electronic pipette X 1
- AC Adapter X 1
- USB cable X 1
- Stand X 1
- User manual X 1
- Calibration card ( ISO8655-6 / DIN12650 ) X 1



## 2. Parts Description

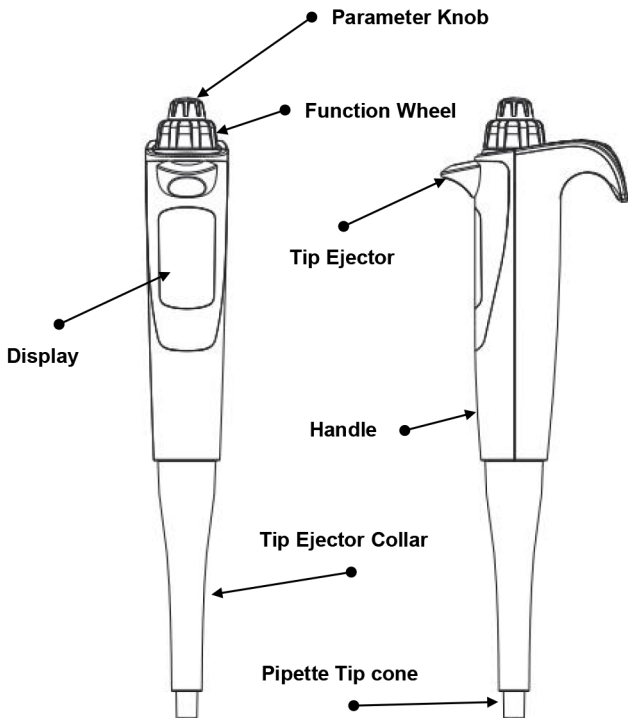



## **Stand Charging Port**

Fully charged in approximate 2 hours.



## **Reset Slot**

Restart AutoPette with the light touch of a pin.

## **USB-charging Port**

Fully charged in approximate 2 hours.

### 3. Display

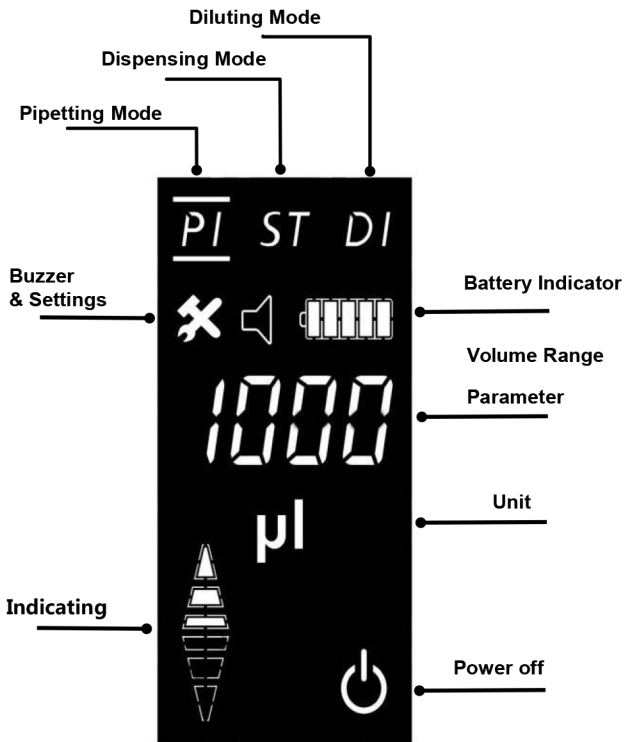

## 4. Operation

### 4.1 Power On

Press the **Parameter Knob** or about 2 seconds.

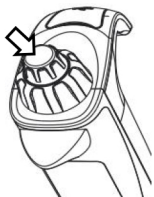

### 4.2 Function Selection

① Fast turn the **Function wheel** right or left, then turn the **Parameter Knob** to do the function Selecting from the blowing item:

1: Pipetting(PI)

2:Dispensing(ST)

3:Diluting(DI)

4:Settings

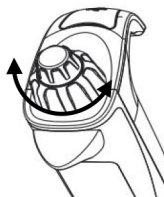

② Clicking **Parameter Knob** to confirm after selecting the Item.

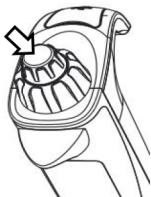

## 4.3 Pipetting (PI)

### 4.3.1 Volume Setting

① Fast turn the **Parameter Knob**.

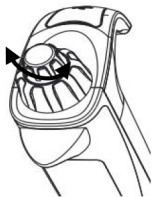

② 'PI' and volume parameter to be blinking.

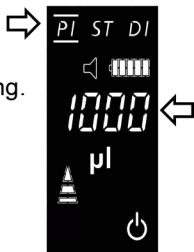

③ Turn the **Parameter Knob** anticlockwise to increase, turn clockwise to decrease.

Press **Parameter Knob** to confirm.

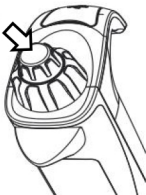

**Note!:** Do volume range setup in Aspirating mode only.

### 4.3.2 Aspiration

When upward arrow blinks, press **Parameter Knob** for Aspiration.

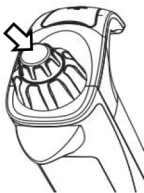

### 4.3.3 Dispensing

When downward arrow blinks, press **Parameter Knob** for dispensing.

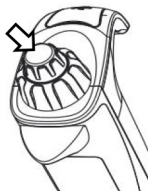

### 4.3.4 Mixing

Press **Parameter Knob** until mixing activity begins.

The release of **Parameter Knob** at any time during the process of mixing will exit the mixing mode.

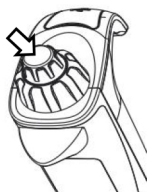

**Note!** Take the operation of AutoPette(10-1000 $\mu$ L) for the purpose of illustration.

Three mixing volume modes in AutoPette:

① If the pipetting volume is set larger than 30% of the total volume range of AutoPette, 30% of the maximum volume of the pipette will be mixed.

**e.g.** set volume: 700 $\mu$ L

actual mixing volume: 300 $\mu$ L



② If the pipetting volume is set less than 30% of the total volume range of AutoPette, and more than its minimum volume range, 50% of the set volume will be mixed.

**e.g.** set volume: 270 $\mu$ L

actual mixing volume: 135 $\mu$ L



③ If 50% of the set volume is less than the minimum volume range of AutoPette, the minimum volume will be mixed.

e.g. set volume: 150 $\mu$ L

actual mixing volume: 100 $\mu$ L



## 4.4 Dispensing (ST)

### 4.4.1 Dispensing volume setting

① Left and right turn **Parameter Knob** to set the one-time dispensing volume. Pressing **Parameter Knob** to confirm.

② Left and right turn **Parameter Knob** to set the one-time dispensing frequency. (The image shows, dispensing frequency is 5 times and each volume is 200 $\mu$ L)

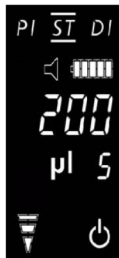



## 4.4.2 Dispensing

Pressing **Parameter Knob** to do liquid dispensing.

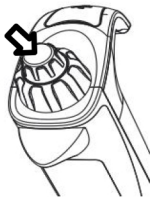

## 4.5 Diluting (DI)

### 4.5.1 Volume setting

① Left and right turn **Parameter Knob** to set the volume of target A.

Pressing **Parameter Knob** to confirm.

② Left and right turn **Parameter Knob** to set the volume of target B.

Pressing **Parameter Knob** to confirm.

## 4.5.2 Diluting

① Pressing **Parameter Knob** to Aspirating target A.



② Remove the Tips from the liquid and Pressing **Parameter Knob** to Aspirating a bit of air.



③ Pressing **Parameter Knob** to Aspirating target B.



④ Pressing **Parameter Knob** to Dispensing target A and B.

## 5. AutoPette setup

Turn **Function wheel** right or left for various settings. Double press of **Parameter Knob** at any time can exit the settings.

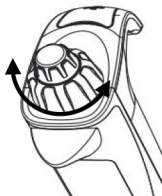

Turn **Function wheel** in any direction for the selection of settings.

Include:

- ① Aspiration speed setting  
(three speeds )
- ② Dispensing speed setting  
(three speeds)
- ③ Buzzer status (ON/OFF)
- ④ Power off

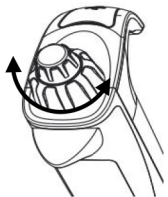

## 5.1 Adjustment of Aspiration / Dispensing Speed

① Use **Function Wheel** to select aspiration or dispensing speed when corresponding signs and parameters start to blink.

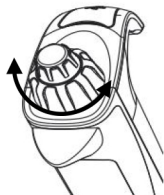

② Fast turn **Parameter Knob** right or left to unlock corresponding setting. Turn **Parameter Knob** right or left to select among three speeds(1,2,3).



e.g. Speed 2 is set in the right diagram.

- ③ Press **Parameter Knob** to confirm.

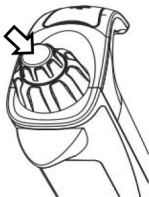

## 5.2 Buzzer Status

- ① Use **Function wheel** to select Buzzer when the corresponding sign starts to blink displaying current status as ON/OFF.

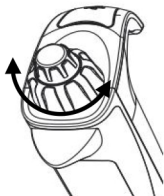

- ② Fast turn **Parameter Knob** right or left to unlock Corresponding setting.  
Turn **Parameter Knob** to the right or left to select between ON and OFF.

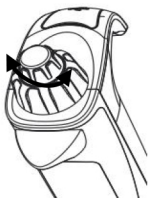

- ③ Press **Parameter Knob** to confirm.

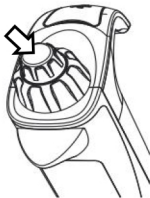

## 5.3 Power off

- ① Use **Function wheel** to select Power when the corresponding sign starts to blink.

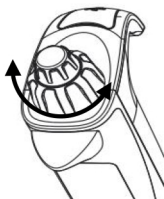

- ② Press **Parameter Knob** to switch the pipette off.

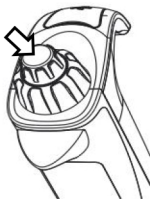

dPette+ will self switch off in 15 minutes being unused.

## 6. Storage

- ① Recommend storing AutoPette electronic pipette on the stand in vertical position when not in use.
- ② Please every month to charging for AutoPette if being unused in long time , make sure there are 50% power in battery at least.
- ③ During storage periods at constant temperature and humidity, the recommended temperature range is from 0-40 °C and humidity no more than 80%.

## 7. Care and Maintenance

By cleaning your AutoPette before and after each use, tip connector in particular, its functionality and performance can be ensured.

**Note!** Check the performance of the pipette every three months. Performance test is recommended to be carried out after each in-house care and maintenance.

### 7.1 Cleaning the Outer Surface

Spay the outer surface with a dedicated pipette detergent or 75% ethanol. Wipe with lint-free cloth.

**Note!** Please consult with your nearest distributor for the cleaning with other detergent or liquids.

ANY WARRANTY WILL, HOWEVER, BE DEEMED AS VOID IF THE FAULT IS FOUND TO HAVE BEEN CAUSED BY UNAUTHORIZED CLEANING.



## 7.2 Sterilizing the Inner Parts

The entire body of AutoPette electronic pipette cannot be autoclaved. The autoclavable parts include:

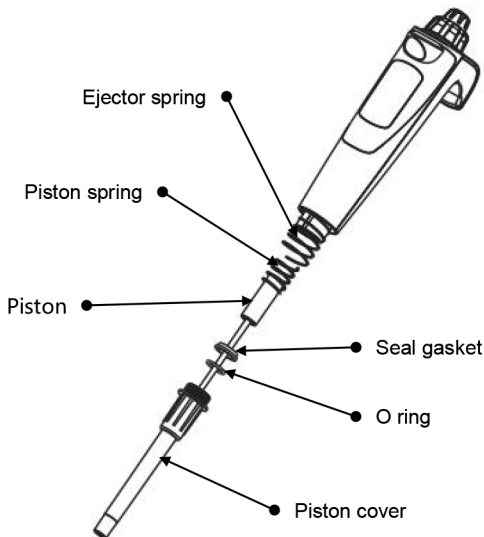

**Note!** The unidentified parts can never be autoclaved or disassembled prior to authorization.

## 7.3 Disassembly Procedures

- ① Unscrew the tip ejector collar anticlockwise and remove it.

**NOTE! THIS PART CANNOT BE AUTOCLAVED.**



- ② Remove the ejector spring. Unscrew the piston cover anticlockwise and remove it.



- ③ Separate the seal gasket and O ring from piston cover.

**NOTE!** MINOR PARTS FOR SAFE KEEPING PLEASE.

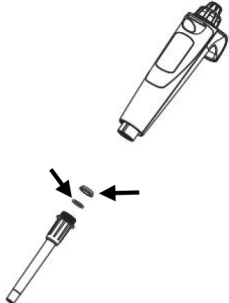

- ④ Separate the remaining piston from piston spring.

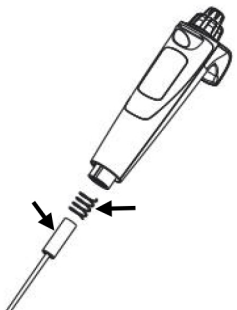

⑤ Clean the above-mentioned parts with 75% ethanol, or sterilize the parts at 121°C, 1 bar overpressure for 20 minutes.

⑥ Apply an appropriate layer of silicone grease to the O ring, seal gasket and piston. Reassembling.

**Note!**

① After autoclaving and reassembling, leave AutoPette to rest for 12 hours before reuse.

② Calibration is needed after each inner-part sterilization. For more information, please refer to section "Calibration and Performance Tests".

## 8. Calibration and Performance Tests

Calibration should take place at 20-25°C, kept constant within  $\pm 0.5^\circ\text{C}$ . A dedicated calibration software will write calibration values in your AutoPette, after the distilled water has been repeatedly weighed at least five times.

### Hardware needed:

- Electronic balance with readability of 0.01 mg
- Distilled water
- Pipette tip in compatible with the volume range of your dPette+
- X86 or X64 architecture PC pre-loaded with Windows (XP/Vista / 7/8/10 operating system)

### Software needed:

- Dedicated calibration software of AutoPette (For more information, please contact with your nearest distributor)
- dPette+ drive program

**Note!** If your AutoPette cannot work properly after calibration, please contact your nearest distributor for assistance.

## 9. Troubleshooting Guide

<b>Problem</b>	<b>Possible cause</b>	<b>Solution</b>
Remaining droplets	Incompatible tip	Use original tip
	Plastic self-lubrication of the tip is not even	
Leakage or inadequate aspiration	Tip is loose	Attach the tip firmly
	Foreign objects between tip and connector	Clean the tip cone and replace the tip
	Pipette is contaminated	Clean and grease O ring, piston and clean tip cone
	Inadequate application of silicone grease to piston or O ring	Apply silicone grease
	O ring and piston is unlocked or broken	Replace O ring
	Inappropriate operation	Follow the instructions in the User Manual

<b>Problem</b>	<b>Possible cause</b>	<b>Solution</b>
Leakage or inadequate aspiration	Calibration needed or huge difference of density compared with water	Recalibrate according to the instructions in the User Manual
	Pipette is broken	Send the pipette for service
Inadequate aspiration due to jammed pipette	liquids leak into the tip connector and dry.	Clean and grease O ring and piston; clean tip cone
ejector is jammed or cannot work properly	Tip connector and ejector are contaminated	Clean tip connector and ejector

## 10. Warranty

AutoPette electronic pipettes are covered by one-year warranty against defects in workmanship and materials. Please contact us or your nearest distributor.

ANY WARRANTY WILL, HOWEVER, BE DEEMED AS VOID DUE TO NORMAL WEAR AND TEAR OR FOR OPERATIONS CONTRARY TO THE INSTRUCTIONS GIVEN IN THIS MANUAL.

Each and every dPette+ has been calibrated and tested in compliance with ISO8655-6 / DIN12650 (calibration card included in the contents of delivery package) when manufactured, ensuring safe and comfortable pipetting.



# 11. Accessory

## 11.1 Stander

Step 1 : There are two piece of adhesive tape on the stander surface. Peel off the release paper of from the adhesive which one you want to use and paste the stander on the flat and clean surface where you want to set up the stander.

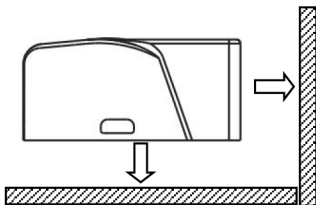
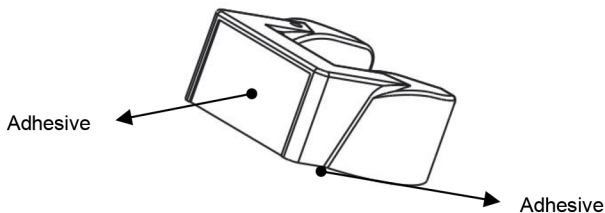

Step2 : Insert the AutoPette stander charging port contact the stander. Connecting USB cable.

